

1 Mbps HIGH CMR ANALOG OUTPUT TYPE  
8-PIN SSOP (SO-8)  
HIGH-SPEED PHOTOCOUPLER

—NEPOC Series—

**DESCRIPTION**

The PS8802-1, -2 are optically coupled isolators containing a GaAlAs LED on the light emitting diode (input side) and a PIN photodiode and a high-speed amplifier transistor on the output side on one chip.

The PS8802-1, -2 are designed specifically for high common mode transient immunity (CMR), the PS8802-2 is suitable for high density applications.

**FEATURES**

- 40% reduction of mounting area (5-pin SOP × 2)
- High common mode transient immunity ( $C_{MH}$ ,  $C_{ML} = \pm 15 \text{ kV}/\mu\text{s MIN.}$ )
- High supply voltage ( $V_{CC} = 35 \text{ V}$ )
- High isolation voltage ( $BV = 2\,500 \text{ Vr.m.s.}$ )
- High-speed response ( $t_{PHL} = 0.8 \mu\text{s MAX.}$ ,  $t_{PLH} = 1.2 \mu\text{s MAX.}$ )
- Ordering number of tape product: PS8802-1-F3, F4: 1 500 pcs/reel  
: PS8802-2-F3, F4: 1 500 pcs/reel
- Pb-Free product
- Safety standards
  - UL approved: File No. E72422
  - DIN EN60747-5-2 (VDE0884 Part2) approved (option)

**APPLICATIONS**

- Computer and peripheral manufactures
- General purpose inverter
- Substitutions for relays and pulse transformers
- Power supply

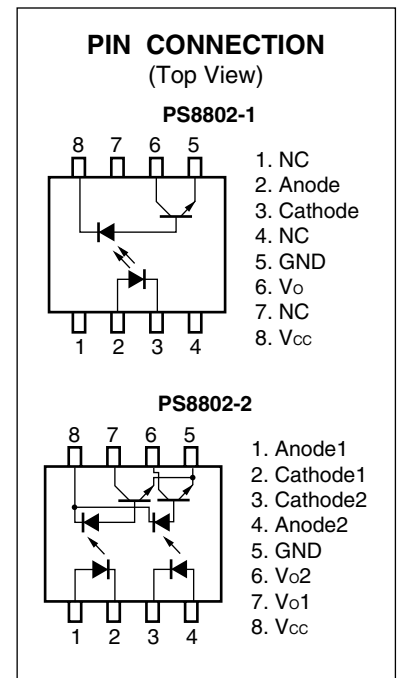

The information in this document is subject to change without notice. Before using this document, please confirm that this is the latest version.  
Not all products and/or types are available in every country. Please check with an NEC Electronics sales representative for availability and additional information.

PACKAGE DIMENSIONS (UNIT: mm)

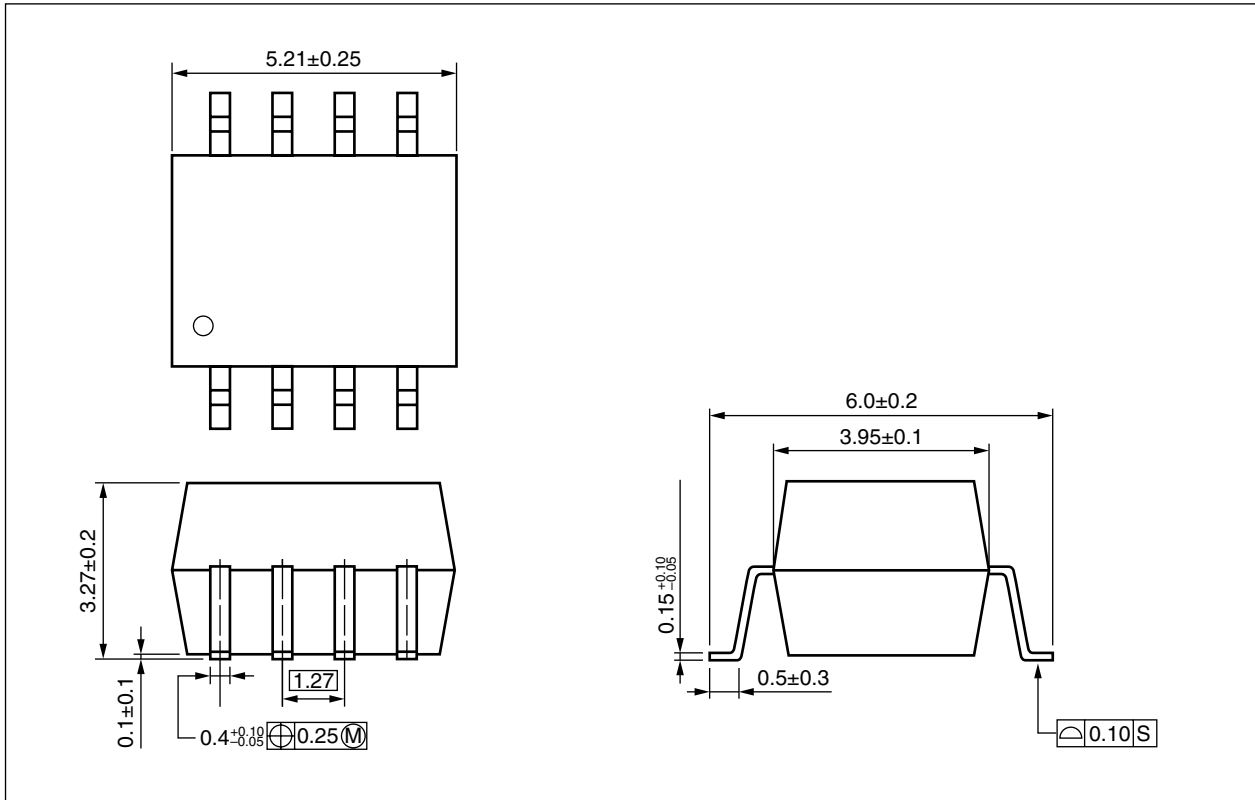

<R> MARKING EXAMPLE

SnBi PLATING

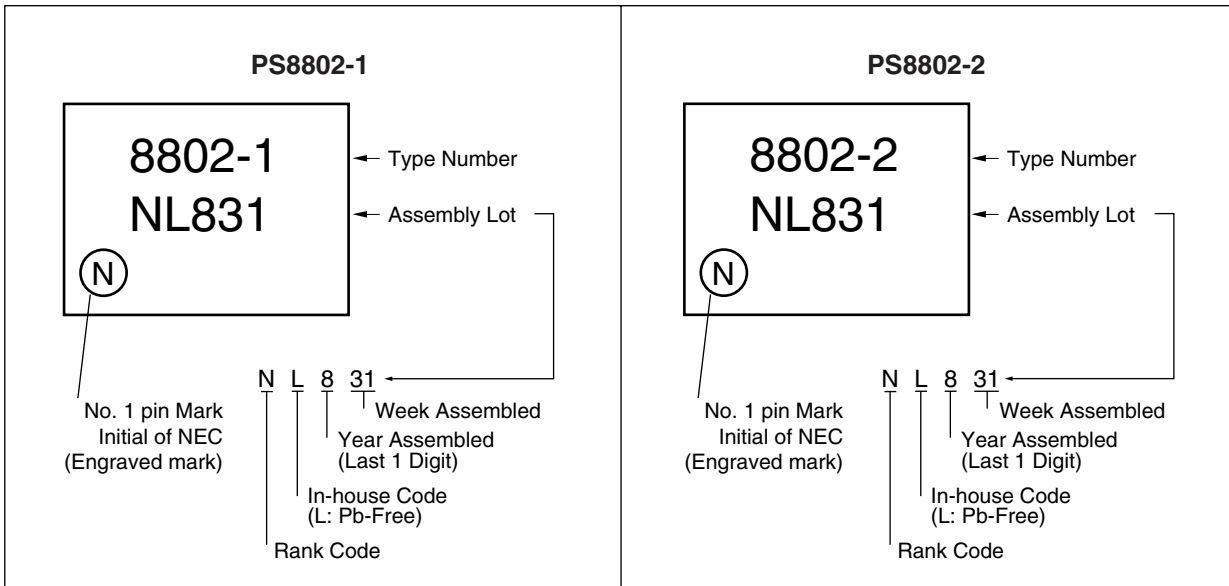

Ni/Pd/Au PLATING

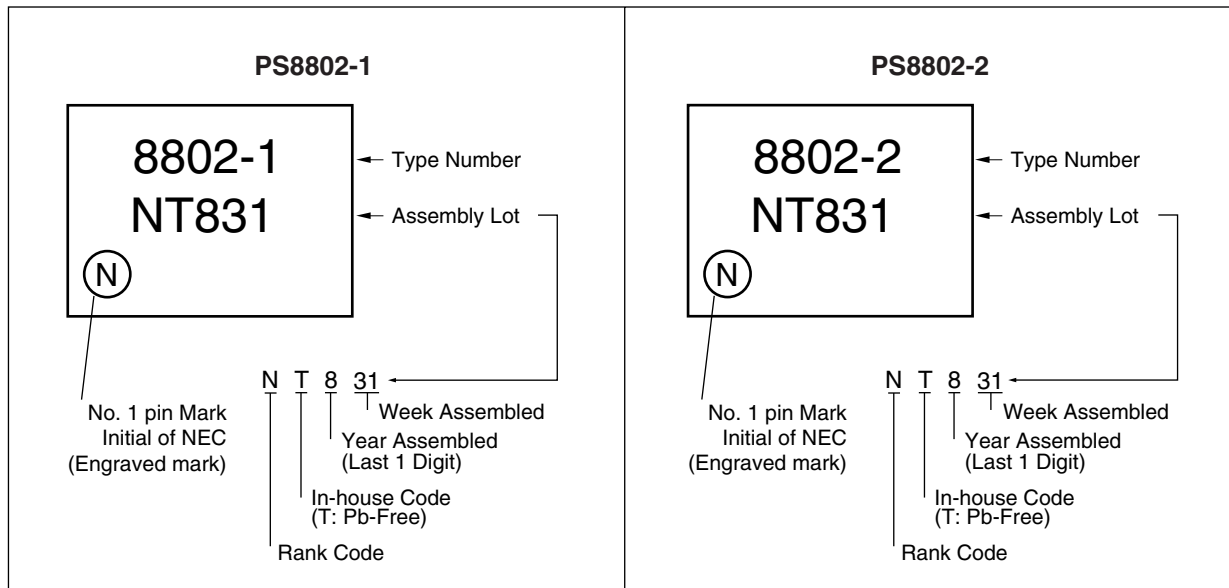

<R> ORDERING INFORMATION

Part Number	Order Number	Solder Plating Specification	Packing Style	Safety Standard Approval	Application Part Number <sup>*1</sup>
PS8802-1	PS8802-1-A	Pb-Free (SnBi)	20 pcs (Tape 20 pcs cut)	Standard products (UL approved)	PS8802-1
PS8802-1-F3	PS8802-1-F3-A		Embossed Tape 1 500 pcs/reel		
PS8802-1-F4	PS8802-1-F4-A				
PS8802-2	PS8802-2-A		20 pcs (Tape 20 pcs cut)		PS8802-2
PS8802-2-F3	PS8802-2-F3-A		Embossed Tape 1 500 pcs/reel		
PS8802-2-F4	PS8802-2-F4-A				
PS8802-1-V	PS8802-1-V-A		20 pcs (Tape 20 pcs cut)	DIN EN60747-5-2 (VDE0884 Part2) Approved (Option)	PS8802-1
PS8802-1-V-F3	PS8802-1-V-F3-A		Embossed Tape 1 500 pcs/reel		
PS8802-1-V-F4	PS8802-1-V-F4-A				
PS8802-2-V	PS8802-2-V-A		20 pcs (Tape 20 pcs cut)		PS8802-2
PS8802-2-V-F3	PS8802-2-V-F3-A		Embossed Tape 1 500 pcs/reel		
PS8802-2-V-F4	PS8802-2-V-F4-A				
PS8802-1	PS8802-1-AX	Pb-Free (Ni/Pd/Au)	20 pcs (Tape 20 pcs cut)	Standard products (UL approved)	PS8802-1
PS8802-1-F3	PS8802-1-F3-AX		Embossed Tape 1 500 pcs/reel		
PS8802-1-F4	PS8802-1-F4-AX				
PS8802-2	PS8802-2-AX		20 pcs (Tape 20 pcs cut)		PS8802-2
PS8802-2-F3	PS8802-2-F3-AX		Embossed Tape 1 500 pcs/reel		
PS8802-2-F4	PS8802-2-F4-AX				
PS8802-1-V	PS8802-1-V-AX		20 pcs (Tape 20 pcs cut)	DIN EN60747-5-2 (VDE0884 Part2) Approved (Option)	PS8802-1
PS8802-1-V-F3	PS8802-1-V-F3-AX		Embossed Tape 1 500 pcs/reel		
PS8802-1-V-F4	PS8802-1-V-F4-AX				
PS8802-2-V	PS8802-2-V-AX		20 pcs (Tape 20 pcs cut)		PS8802-2
PS8802-2-V-F3	PS8802-2-V-F3-AX		Embossed Tape 1 500 pcs/reel		
PS8802-2-V-F4	PS8802-2-V-F4-AX				

\*1 For the application of the Safety Standard, following part number should be used.

**ABSOLUTE MAXIMUM RATINGS (T<sub>A</sub> = 25°C, unless otherwise specified)**

Parameter		Symbol	Ratings	Unit
Diode	Forward Current	I <sub>F</sub>	25	mA/ch
	Reverse Voltage	V <sub>R</sub>	5.0	V/ch
	Power Dissipation <sup>1</sup>	P <sub>D</sub>	45	mW/ch
Detector	Supply Voltage	V <sub>CC</sub>	35	V
	Output Voltage	V <sub>O</sub>	35	V/ch
	Output Current	I <sub>O</sub>	8.0	mA/ch
	Power Dissipation <sup>2</sup>	P <sub>C</sub>	100	mW/ch
Isolation Voltage <sup>3</sup>		BV	2 500	Vr.m.s.
Operating Ambient Temperature		T <sub>A</sub>	-55 to +100	°C
Storage Temperature		T <sub>stg</sub>	-55 to +125	°C

\*1 Reduced to 0.45 mW/°C at T<sub>A</sub> = 25°C or more.

\*2 Reduced to 1.00 mW/°C at T<sub>A</sub> = 25°C or more.

\*3 AC voltage for 1 minute at T<sub>A</sub> = 25°C, RH = 60% between input and output.  
Pins 1-4 shorted together, 5-8 shorted together.

ELECTRICAL CHARACTERISTICS (T<sub>A</sub> = 25°C)

Parameter		Symbol	Conditions	MIN.	TYP.	MAX.	Unit
Diode	Forward Voltage	V <sub>F</sub>	I <sub>F</sub> = 16 mA		1.7	2.2	V
	Reverse Current	I <sub>R</sub>	V <sub>R</sub> = 3 V			10	μA
	Forward Voltage Temperature Coefficient	ΔV <sub>F</sub> /ΔT <sub>A</sub>	I <sub>F</sub> = 16 mA		-2.1		mV/°C
	Terminal Capacitance	C <sub>t</sub>	V = 0 V, f = 1 MHz		30		pF
Detector	High Level Output Current	I <sub>OH</sub> (1)	I <sub>F</sub> = 0 mA, V <sub>CC</sub> = V <sub>O</sub> = 5.5 V		10	500	nA
	High Level Output Current	I <sub>OH</sub> (2)	I <sub>F</sub> = 0 mA, V <sub>CC</sub> = V <sub>O</sub> = 30 V			100	μA
	Low Level Output Voltage	V <sub>OL</sub>	I <sub>F</sub> = 16 mA, V <sub>CC</sub> = 4.5 V, I <sub>OL</sub> = 1.2 mA		0.1	0.4	V
	High Level Supply Current (PS8802-1)	I <sub>CC</sub> H	I <sub>F</sub> = 0 mA, V <sub>O</sub> = open, V <sub>CC</sub> = 30 V		0.1	2	μA
	High Level Supply Current (PS8802-2)				0.2	4	
	Low Level Supply Current (PS8802-1)	I <sub>CC</sub> L	I <sub>F</sub> = 16 mA, V <sub>O</sub> = open, V <sub>CC</sub> = 30 V		100		
	Low Level Supply Current (PS8802-2)				200		
Coupled	Current Transfer Ratio	CTR	I <sub>F</sub> = 16 mA, V <sub>CC</sub> = 4.5 V, V <sub>O</sub> = 0.4 V	15	25	45	%
	Input-Output Isolation Resistance	R <sub>I-O</sub>	V <sub>I-O</sub> = 1 kV <sub>DC</sub> , R <sub>H</sub> = 40 to 60%	10 <sup>11</sup>			Ω
	Insulation Resistance (Input-Input), (PS8802-2)	R <sub>I-I</sub>	V <sub>I-I</sub> = 1 kV <sub>DC</sub> , R <sub>H</sub> = 40 to 60%	10 <sup>10</sup>			
	Input-Output Isolation Capacitance	C <sub>I-O</sub>	V = 0 V, f = 1 MHz		0.6		pF
	Insulation Capacitance (Input-Input), (PS8802-2)	C <sub>I-I</sub>			0.3		
	Propagation Delay Time (H → L) <sup>1</sup>	t <sub>PHL</sub>	I <sub>F</sub> = 16 mA, V <sub>CC</sub> = 5 V, R <sub>L</sub> = 2.2 kΩ, C <sub>L</sub> = 15 pF		0.3	0.8	μs
	Propagation Delay Time (L → H) <sup>1</sup>	t <sub>PLH</sub>			0.6	1.2	
	Common Mode Transient Immunity at High Level Output <sup>2</sup>	C <sub>MH</sub>	I <sub>F</sub> = 0 mA, V <sub>CC</sub> = 5 V, R <sub>L</sub> = 4.1 kΩ, V <sub>CM</sub> = 1.5 kV	15			kV/μs
	Common Mode Transient Immunity at Low Level Output <sup>2</sup>	C <sub>ML</sub>	I <sub>F</sub> = 16 mA, V <sub>CC</sub> = 5 V, R <sub>L</sub> = 4.1 kΩ, V <sub>CM</sub> = 1.5 kV	-15			

\*1 Test circuit for propagation delay time

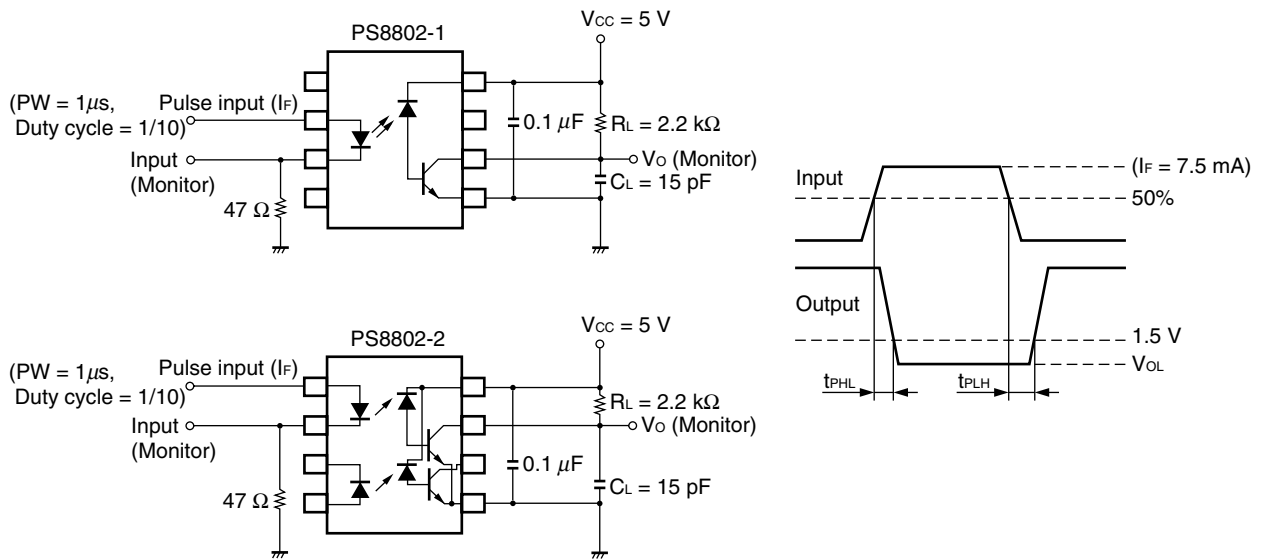

**Remark**  $C_L$  is approximately 15 pF which includes probe and stray wiring capacitance.

\*2 Test circuit for common mode transient immunity

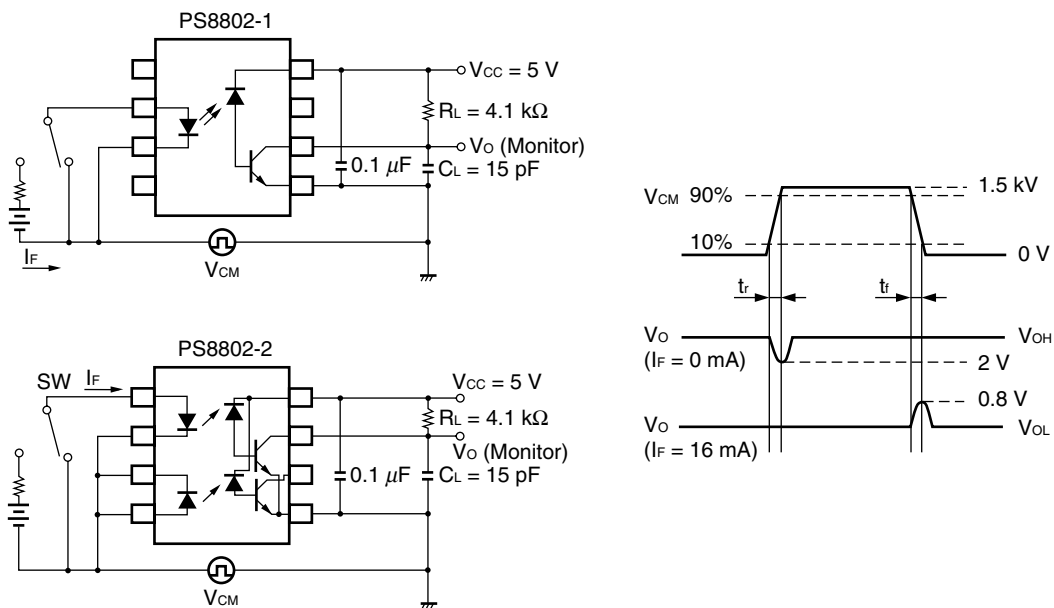

**USAGE CAUTIONS**

1. This product is weak for static electricity by designed with high-speed integrated circuit so protect against static electricity when handling.
2. By-pass capacitor of 0.1  $\mu\text{F}$  is used between  $V_{CC}$  and GND near device. Also, ensure that the distance between the leads of the photocoupler and capacitor is no more than 10 mm.
3. Avoid storage at a high temperature and high humidity.

**TYPICAL CHARACTERISTICS ( $T_A = 25^\circ\text{C}$ , unless otherwise specified)**

**DIODE POWER DISSIPATION vs. AMBIENT TEMPERATURE**

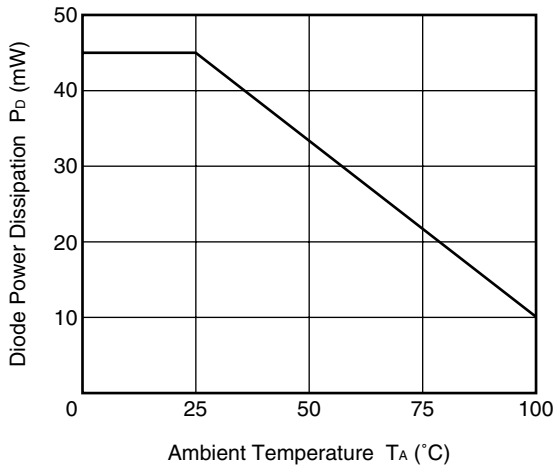

**TRANSISTOR POWER DISSIPATION vs. AMBIENT TEMPERATURE**

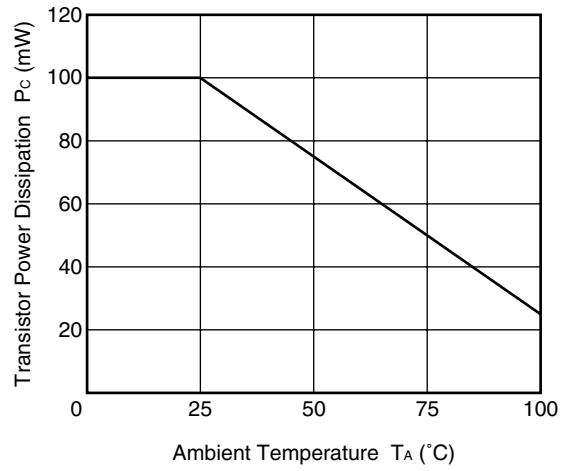

**FORWARD CURRENT vs. FORWARD VOLTAGE**

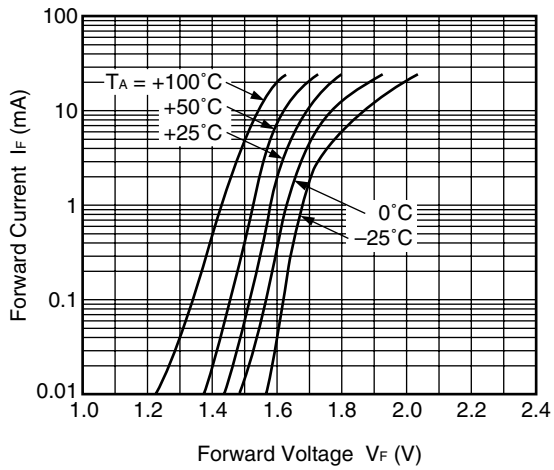

**HIGH LEVEL OUTPUT CURRENT vs. AMBIENT TEMPERATURE**

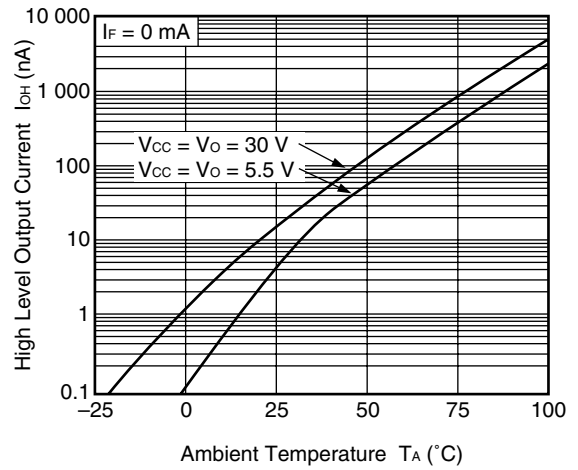

**CURRENT TRANSFER RATIO vs. FORWARD CURRENT**

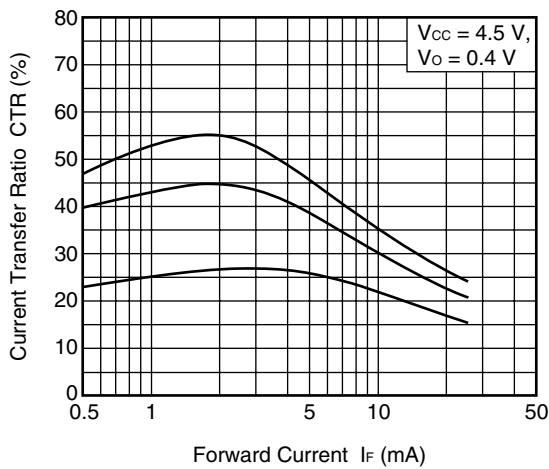

**NORMALIZED CURRENT TRANSFER RATIO vs. AMBIENT TEMPERATURE**

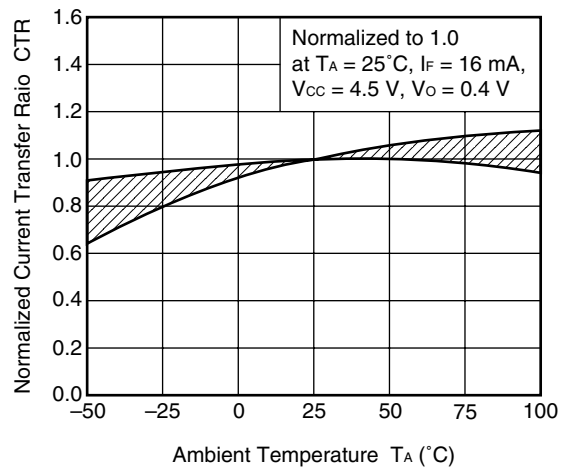

**Remark** The graphs indicate nominal characteristics.



OUTPUT CURRENT vs. OUTPUT VOLTAGE

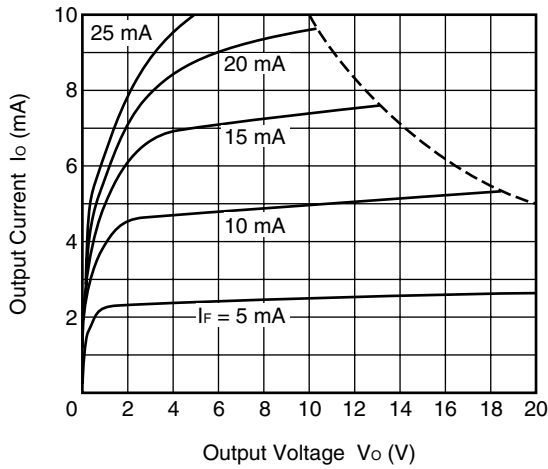

OUTPUT VOLTAGE vs. FORWARD CURRENT

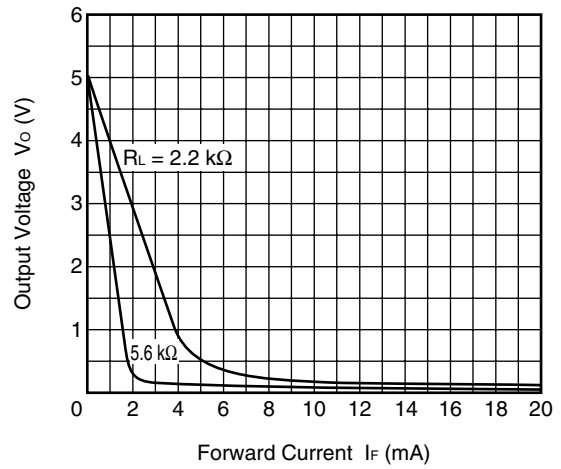

PROPAGATION DELAY TIME vs. FORWARD CURRENT

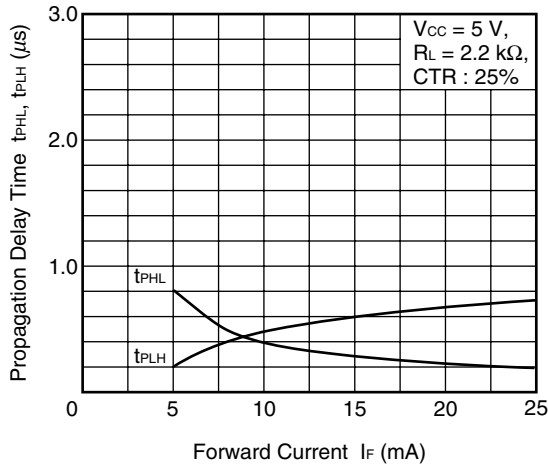

PROPAGATION DELAY TIME vs. LOAD RESISTANCE

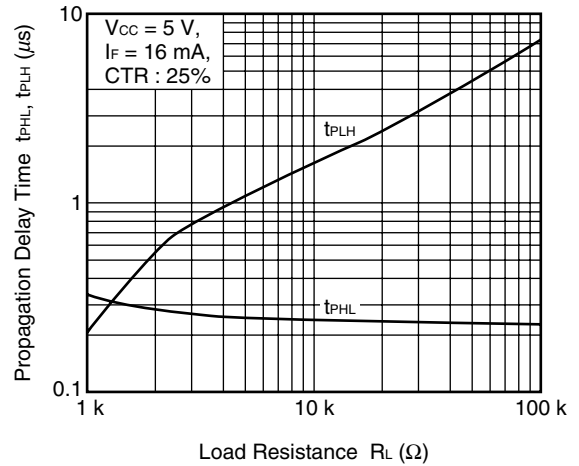

NORMALIZED PROPAGATION DELAY TIME vs. AMBIENT TEMPERATURE

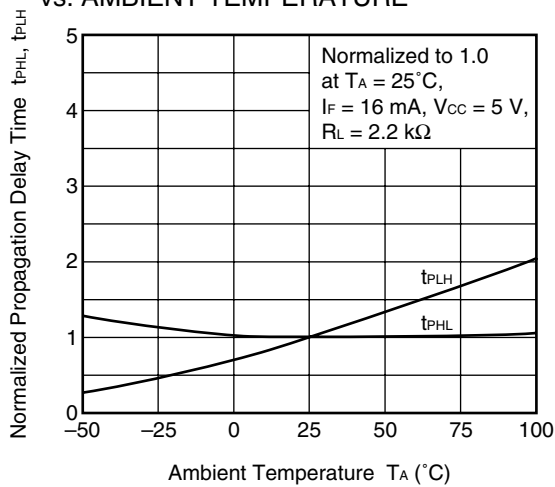

**Remark** The graphs indicate nominal characteristics.

TAPING SPECIFICATIONS (UNIT: mm)

Outline and Dimensions (Tape)

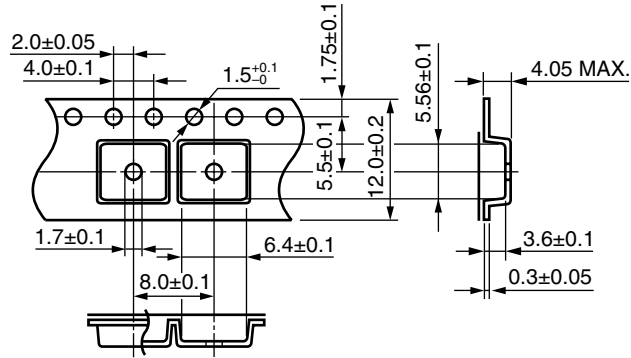

Taping Direction

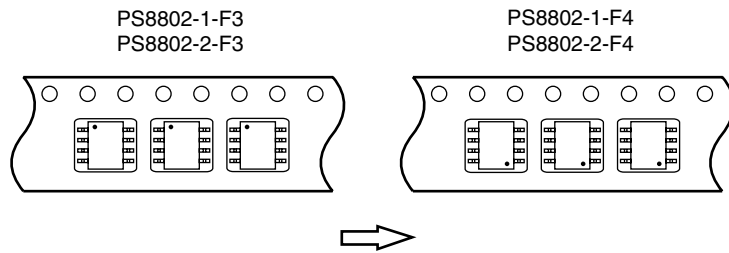

Outline and Dimensions (Reel)

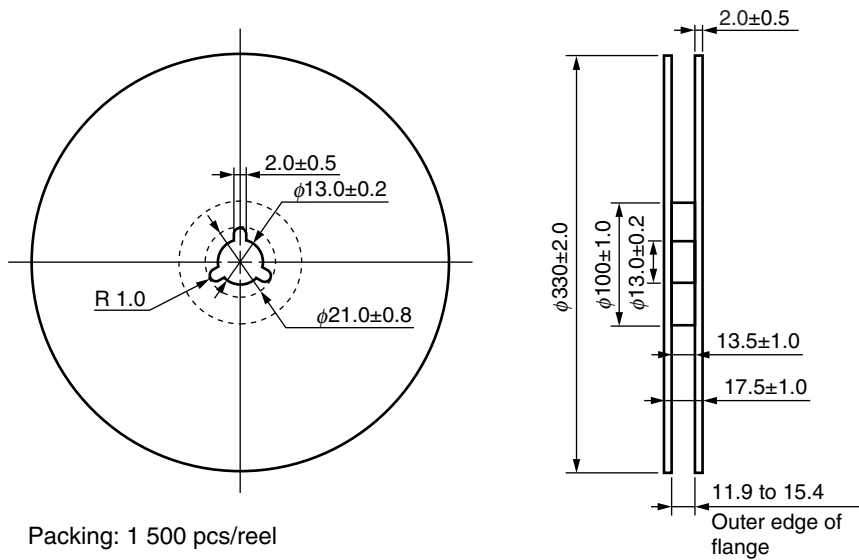

RECOMMENDED MOUNT PAD DIMENSIONS (UNIT: mm)

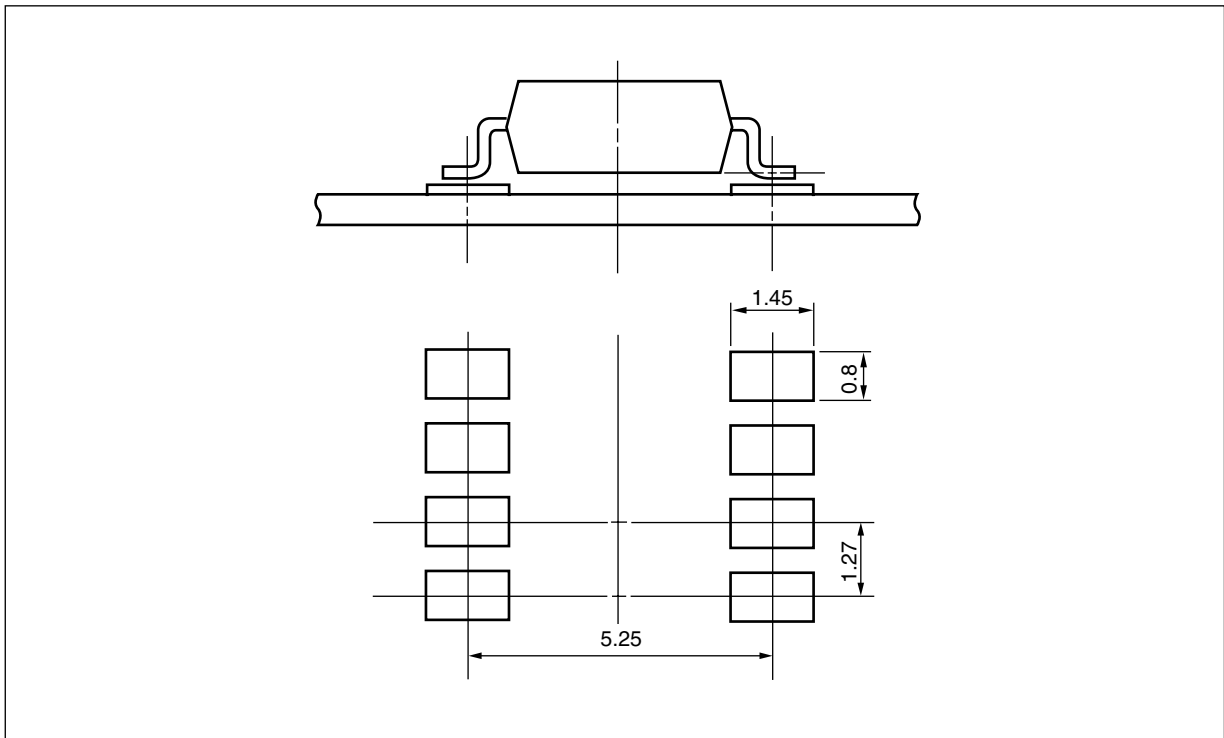

**NOTES ON HANDLING**

**1. Recommended soldering conditions**

**(1) Infrared reflow soldering**

- Peak reflow temperature 260°C or below (package surface temperature)
- Time of peak reflow temperature 10 seconds or less
- Time of temperature higher than 220°C 60 seconds or less
- Time to preheat temperature from 120 to 180°C 120±30 s
- Number of reflows Three
- Flux Rosin flux containing small amount of chlorine (The flux with a maximum chlorine content of 0.2 Wt% is recommended.)

Recommended Temperature Profile of Infrared Reflow

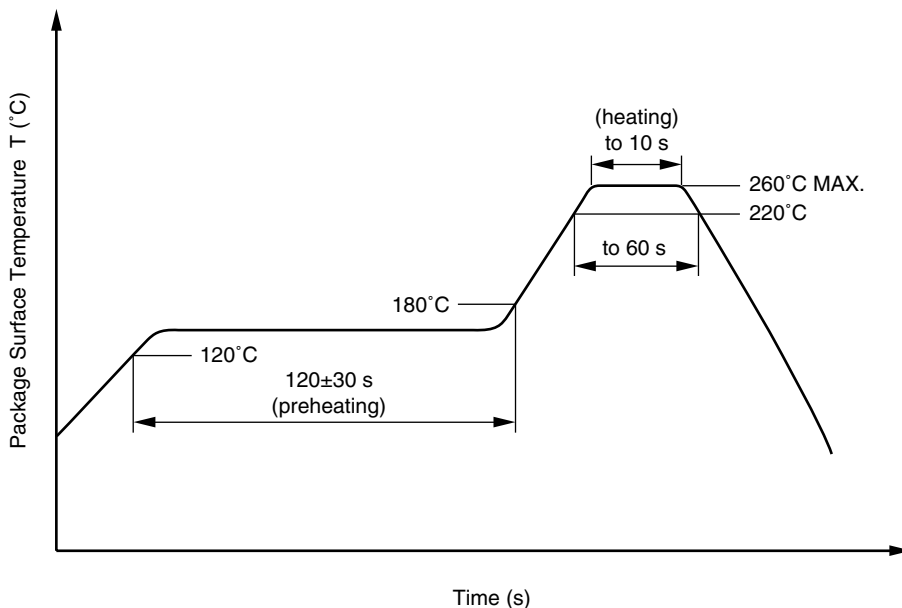

**(2) Wave soldering**

- Temperature 260°C or below (molten solder temperature)
- Time 10 seconds or less
- Preheating conditions 120°C or below (package surface temperature)
- Number of times One (Allowed to be dipped in solder including plastic mold portion.)
- Flux Rosin flux containing small amount of chlorine (The flux with a maximum chlorine content of 0.2 Wt% is recommended.)

**(3) Soldering by soldering iron**

- Peak temperature (lead part temperature) 350°C or below
- Time (each pins) 3 seconds or less
- Flux Rosin flux containing small amount of chlorine (The flux with a maximum chlorine content of 0.2 Wt% is recommended.)

- (a) Soldering of leads should be made at the point 1.5 to 2.0 mm from the root of the lead.
- (b) Please be sure that the temperature of the package would not be heated over 100°C.

**(4) Cautions**

- Fluxes

Avoid removing the residual flux with freon-based and chlorine-based cleaning solvent.

**2. Cautions regarding noise**

Be aware that when voltage is applied suddenly between the photocoupler's input and output or between collector-emitters at startup, the output transistor may enter the on state, even if the voltage is within the absolute maximum ratings.

**USAGE CAUTIONS**

1. Protect against static electricity when handling.
2. Avoid storage at a high temperature and high humidity.

<R> SPECIFICATION OF VDE MARKS LICENSE DOCUMENT

Parameter	Symbol	Speck	Unit
Application classification (DIN EN 60664-1 VDE0110 Part 1) for rated line voltages ≤ 300 Vr.m.s. for rated line voltages ≤ 600 Vr.m.s.		IV III	
Climatic test class (DIN EN 60664-1 VDE0110)		55/100/21	
Dielectric strength maximum operating isolation voltage Test voltage (partial discharge test, procedure a for type test and random test) $U_{pr} = 1.5 \times U_{IORM}, P_d < 5 \text{ pC}$	$U_{IORM}$ $U_{pr}$	566 849	$V_{peak}$ $V_{peak}$
Test voltage (partial discharge test, procedure b for all devices) $U_{pr} = 1.875 \times U_{IORM}, P_d < 5 \text{ pC}$	$U_{pr}$	1 061	$V_{peak}$
Highest permissible overvoltage	$U_{TR}$	4 000	$V_{peak}$
Degree of pollution (DIN EN 60664-1 VDE0110 Part 1)		2	
Clearance distance		>4.0	mm
Creepage distance		>4.0	mm
Comparative tracking index (DIN IEC 112/VDE 0303 Part 1)	CTI	175	
Material group (DIN EN 60664-1 VDE0110 Part 1)		III a	
Storage temperature range	$T_{stg}$	-55 to +125	°C
Operating temperature range	$T_A$	-55 to +100	°C
Isolation resistance, minimum value $V_{IO} = 500 \text{ V dc at } T_A = 25^\circ\text{C}$ $V_{IO} = 500 \text{ V dc at } T_A \text{ MAX. at least } 100^\circ\text{C}$	Ris MIN. Ris MIN.	$10^{12}$ $10^{11}$	$\Omega$ $\Omega$
Safety maximum ratings (maximum permissible in case of fault, see thermal derating curve) Package temperature Current (input current $I_F, P_{si} = 0$ ) Power (output or total power dissipation) Isolation resistance $V_{IO} = 500 \text{ V dc at } T_A = T_{si}$	$T_{si}$ $I_{si}$ $P_{si}$ Ris MIN.	150 150 600 $10^9$	°C mA mW $\Omega$

• **The information in this document is current as of August, 2008. The information is subject to change without notice. For actual design-in, refer to the latest publications of NEC Electronics data sheets or data books, etc., for the most up-to-date specifications of NEC Electronics products. Not all products and/or types are available in every country. Please check with an NEC Electronics sales representative for availability and additional information.**

- No part of this document may be copied or reproduced in any form or by any means without the prior written consent of NEC Electronics. NEC Electronics assumes no responsibility for any errors that may appear in this document.
- NEC Electronics does not assume any liability for infringement of patents, copyrights or other intellectual property rights of third parties by or arising from the use of NEC Electronics products listed in this document or any other liability arising from the use of such products. No license, express, implied or otherwise, is granted under any patents, copyrights or other intellectual property rights of NEC Electronics or others.
- Descriptions of circuits, software and other related information in this document are provided for illustrative purposes in semiconductor product operation and application examples. The incorporation of these circuits, software and information in the design of a customer's equipment shall be done under the full responsibility of the customer. NEC Electronics assumes no responsibility for any losses incurred by customers or third parties arising from the use of these circuits, software and information.
- While NEC Electronics endeavors to enhance the quality, reliability and safety of NEC Electronics products, customers agree and acknowledge that the possibility of defects thereof cannot be eliminated entirely. To minimize risks of damage to property or injury (including death) to persons arising from defects in NEC Electronics products, customers must incorporate sufficient safety measures in their design, such as redundancy, fire-containment and anti-failure features.
- NEC Electronics products are classified into the following three quality grades: "Standard", "Special" and "Specific".

The "Specific" quality grade applies only to NEC Electronics products developed based on a customer-designated "quality assurance program" for a specific application. The recommended applications of an NEC Electronics product depend on its quality grade, as indicated below. Customers must check the quality grade of each NEC Electronics product before using it in a particular application.

"Standard": Computers, office equipment, communications equipment, test and measurement equipment, audio and visual equipment, home electronic appliances, machine tools, personal electronic equipment and industrial robots.

"Special": Transportation equipment (automobiles, trains, ships, etc.), traffic control systems, anti-disaster systems, anti-crime systems, safety equipment and medical equipment (not specifically designed for life support).

"Specific": Aircraft, aerospace equipment, submersible repeaters, nuclear reactor control systems, life support systems and medical equipment for life support, etc.

The quality grade of NEC Electronics products is "Standard" unless otherwise expressly specified in NEC Electronics data sheets or data books, etc. If customers wish to use NEC Electronics products in applications not intended by NEC Electronics, they must contact an NEC Electronics sales representative in advance to determine NEC Electronics' willingness to support a given application.

(Note)

(1) "NEC Electronics" as used in this statement means NEC Electronics Corporation and also includes its majority-owned subsidiaries.

(2) "NEC Electronics products" means any product developed or manufactured by or for NEC Electronics (as defined above).

<p><b>Caution</b></p>	<p>GaAs Products</p>	<p>This product uses gallium arsenide (GaAs). GaAs vapor and powder are hazardous to human health if inhaled or ingested, so please observe the following points.</p> <ul style="list-style-type: none"> <li>• Follow related laws and ordinances when disposing of the product. If there are no applicable laws and/or ordinances, dispose of the product as recommended below.             <ol style="list-style-type: none"> <li>1. Commission a disposal company able to (with a license to) collect, transport and dispose of materials that contain arsenic and other such industrial waste materials.</li> <li>2. Exclude the product from general industrial waste and household garbage, and ensure that the product is controlled (as industrial waste subject to special control) up until final disposal.</li> </ol> </li> <li>• Do not burn, destroy, cut, crush, or chemically dissolve the product.</li> <li>• Do not lick the product or in any way allow it to enter the mouth.</li> </ul>
-----------------------	----------------------	---